

Translation of the Original- Operating Instructions

RailMAB 960

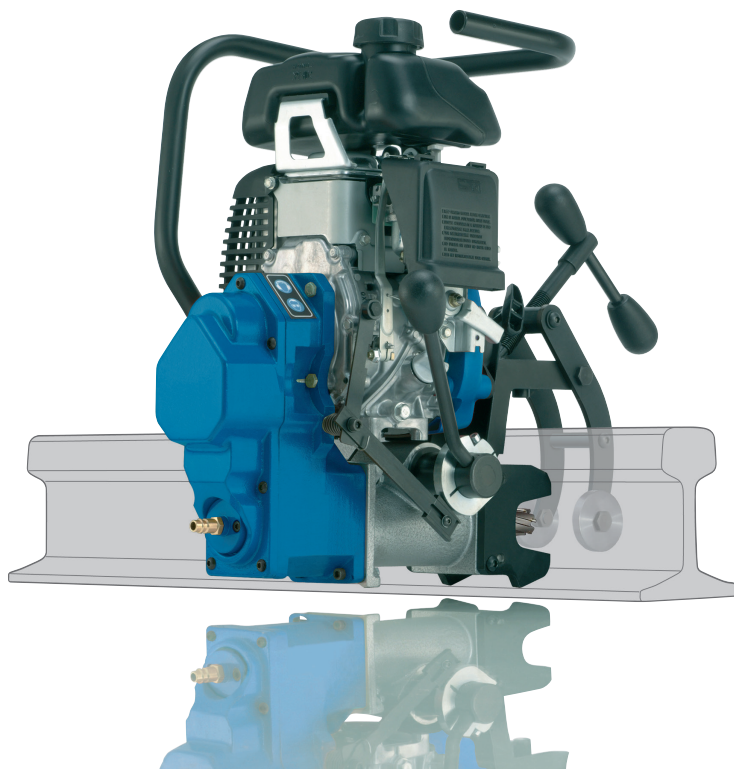

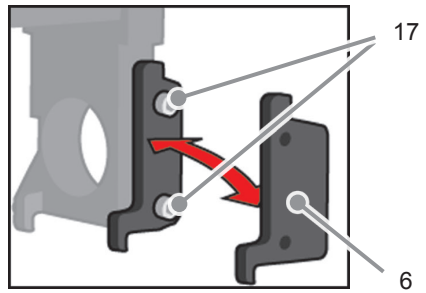
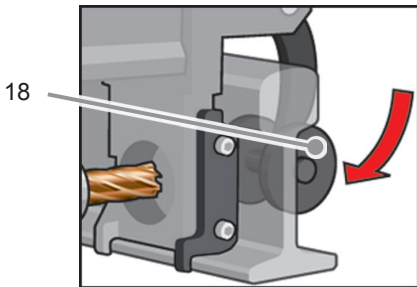
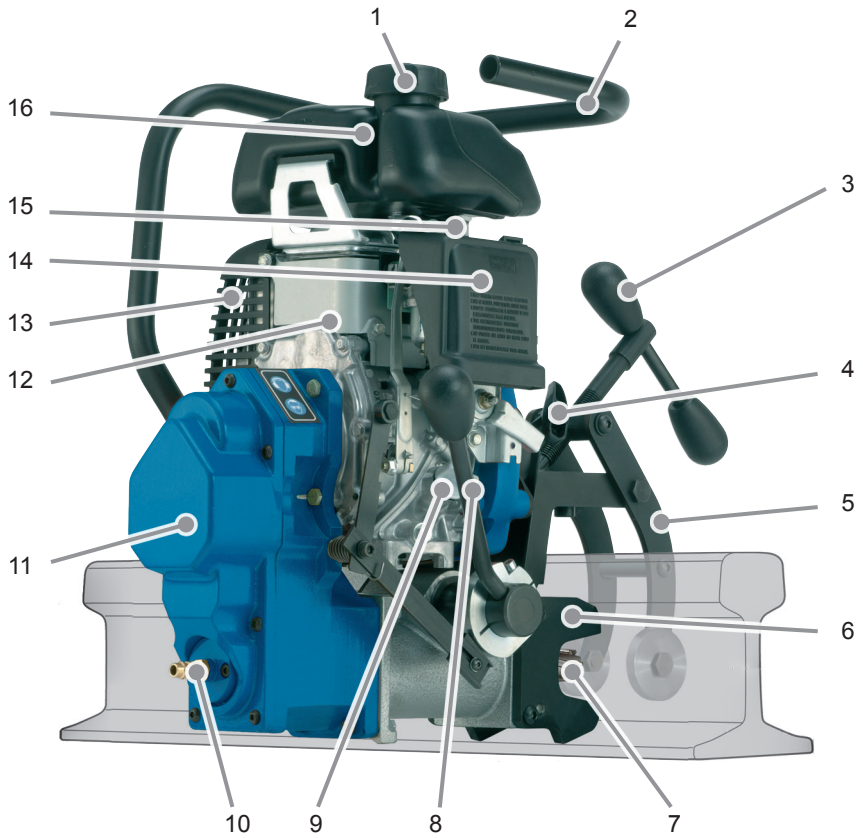

Table of Contents

General instructions	3
Safety	5
Components/delivery contents	9
Before using for the first time	9
Preparation	10
Use	14
Eliminating blockages	17
Cleaning	18
Maintenance	18
Storage	19
Troubleshooting	19
Technical data	20
EC Declaration of Conformity	21

Dear Customer,

Before using the machine, please read the instructions contained in these operating instructions on startup, safety, intended use as well as cleaning and care.

The links and illustrations in these instructions refer to the illustrations on the inside of the cover.

Keep these operating instructions for later use and pass them onto the next owner of the machine.

General instructions

Copyright

This document is copyrighted. Any duplication or reprinting, in whole or in part, and the reproduction of the illustrations even in modified form is only permitted with the written approval of the manufacturer.

Liability disclaimer

All technical information, data and instructions for commissioning, operation and maintenance of the machine contained in these operating instructions represent the latest status at the time of printing.

The manufacturer assumes no liability for damage or injury resulting from failure to observe the operating instructions, use for other than the intended purpose, unprofessional repairs, unauthorised modifications or use of non-approved spare parts and accessories, tools and lubricants.

Instructions on disposal



The packaging materials used can be recycled. When no longer required, dispose of the packaging materials in accordance with the local regulations in force.



This product may not be disposed of in the domestic refuse within the European Union. Dispose of the device via communal collection points.

Safety warning structure

The following warnings are used in these operating instructions:

DANGER

A warning of this category indicates an impending dangerous situation.

If the dangerous situation is not avoided, it may lead to serious injury or even death.

- ▶ Follow the instructions in this warning to avoid possible danger of serious injury or even death.

WARNING

A warning of this category indicates a potentially dangerous situation.

If the dangerous situation is not avoided, it may lead to injuries.

- ▶ Follow the instructions in this warning to avoid possible danger of serious personal injuries.

CAUTION

A warning of this category draws attention to potential material damage.

If the situation is not avoided, it may lead to material damage.

- ▶ Follow the instructions in this warning to avoid material damage.

NOTE

- ▶ A note indicates additional information that simplifies the use of the machine.

Intended use

The machine is intended solely for drilling operations in rails within the limits specified in the technical data.

Any use other than previously stated is considered as improper use.

WARNING

Danger resulting from improper use!

If not used for its intended purpose and/ or used in any other way, the machine may be or become a source of danger.

- ▶ Use the machine only for its intended purpose.
- ▶ Observe the procedures described in these operating instructions.

No claims of any kind will be accepted for damage resulting from use of the appliance for other than its intended purpose.

The risk must be borne solely by the user.

NOTE

- ▶ If used commercially, pay attention to compliance with the accident prevention and occupational safety regulations.

Safety

WARNING

When using engine-powered tools, the following fundamental precautions must be taken to protect against electric shock, fire, injuries and damage to property!

Fundamental safety precautions

- Do not use the machine in flammable or potentially explosive environments.
- Never operate the machine in closed rooms.
- Never refuel the machine when it is hot.
- When refuelling the machine, use suitable auxiliary resources (e.g.: funnel,...)
- Only use the prescribed fuels and lubrication.
- Persons who are unable to operate the appliance due to their physical, mental or motor response abilities may only use the appliance under supervision or instruction by a responsible person.
- Children must not be allowed to use the machine.
- Before using, check the machine for damage and do not put a damaged machine into operation.
- Before beginning work, check the condition of the machine and the function of the operating elements.
- Repairs to the machine may only be carried out by an authorised specialist workshop or by the works customer service. Unqualified repairs can lead to considerable danger for the user.
- Repairs to the machine during the warranty period may only be carried out by a service centre authorised by the manufacturer otherwise the guarantee will be invalidated.
- Defective parts may only be replaced with original spare parts. Only original spare parts guarantee that the safety requirements are met.
- Do not leave the machine unsupervised during operation.
- Store the machine in a dry, temperate location out of the reach of children.
- Do not allow the machine to stand outside and do not expose to moisture.
- Make sure that your work area is sufficiently lit (>300 Lux).
- Do not use low-power machines for heavy working.
- Make sure that your workplace is clean.
- Keep the machine clean, dry and free of oil and grease.
- Follow the instructions on lubricating and cooling the tool.

Dangers from exhaust gases

DANGER

Danger to life from exhaust gases!
Inhaling the exhaust of the engine (12) can lead to suffocation!

Observe the following safety instructions to avoid danger from exhaust gases.

- ▶ Never operate the machine in closed rooms.
- ▶ Avoid inhaling exhaust gases.
- ▶ Pay attention the engine specifications of the manufacturer (12).

Risk of injury!

WARNING

Danger of injury, fire and explosion!

Pay attention to the following safety notes to avoid danger:

- ▶ Only touch the engine (12) after it has cooled down.
- ▶ Refuel the machine only when it has been switched off.
- ▶ Only handle fuels in a well-ventilated environment.
- ▶ Pay attention to the product data sheet of the fuel.
- ▶ Pay attention the engine specifications of the manufacturer (12).

WARNING

Risk of injury from engine starting unintentionally!

Pay attention to the following safety notes to avoid danger from the engine (12) starting unintentionally:

For safe stopping of the engine (12):

- ▶ Move the accelerator (19) to the MIN position.
- ▶ Move the ignition switch (20) of the engine (12) to the OFF/AUS position.
- ▶ Close the fuel tap (21).
- ▶ Pay attention to the engine specifications of the manufacturer (12).

⚠ WARNING**Improper handling of the machine increases the risk of injury!**

Observe the following safety precautions to avoid injuring yourself and/or others:

- ▶ Operate the machine only with the protective equipment stipulated in these operating instructions (see section **Personal protective equipment**).
- ▶ **Do not** wear protective gloves when the machine is running. A glove can be caught by the drilling machine and torn off the hand. Risk of losing one or more fingers.
- ▶ Remove loose jewellery before beginning work. Wear a hair net if you have long hair.
- ▶ Always switch off the machine before changing tools, performing maintenance or cleaning. Wait until the machine has come to a complete standstill.
- ▶ Ensure that the machine is in a safe condition before changing any tools and before maintenance and cleaning in order to avoid unintentional starting of the machine.

⚠ WARNING

- ▶ Do not put your hand into the machine while it is in operation. Remove swarf only when the machine is at a standstill. Wear protective gloves when removing swarf.
- ▶ Before using each time, check for firm stability of the quick clamping system (5) on the rail (see section **Preparation**).
- ▶ Check that the tool is tightened securely before using (see section **Inserting the tool**).

Preventing damage**CAUTION****Potential damage to property if the machine is improperly used!**

Observe the following instructions to avoid damage:

- ▶ Use the prescribed operating materials (fuel, oil...) only.
- ▶ Pay attention the engine specifications of the manufacturer (12).
- ▶ Always carry the machine by the handle (2).
- ▶ Always keep the machine upright.

Safety equipment

Oil level monitoring

The engine (12) is also equipped with oil level monitoring. The machine cannot be started if the oil level is not sufficient before starting.

Check the oil level:

- ▶ See section "Preparing the engine and checking/filling oil".

Symbols on the machine

NOTE

- ▶ Pay attention to the documentation of the manufacturer.

The symbols on the machine have the following meaning:

Symbol	Meaning
	Read the operating instructions before beginning work!
	Wear protective goggles and ear protection!

Personal protective equipment

Wear the following protective equipment at all times when operating the machine:

Symbol	Meaning
	Close-fitting work protection clothing with a low tear strength
	Goggles for protecting eyes against flying parts and liquids and ear protection in areas with noise emission >80 dB(A)
	Safety shoes for protecting feet against falling objects

Wear the following additional protective equipment during special operations:

Symbol	Meaning
	Helmet for protecting your head against falling objects
	Wear a safety belt where there is a danger of falling.
	Gloves for protection against injuries

Components / scope of supply

Machine overview

1	Tank cover
2	Carrying handle
3	Spindle key (fast clamping system)
4	Starter handle
5	Fast clamping system
6	Rail adapter
7	Core drill (not supplied as standard)
8	Feed lever
9	Oil filler neck
10	Pressure connector for coolant/lubrication supply
11	Reduction gear
12	Drive engine
13	Exhaust
14	Air filter
15	Choke
16	Tank
17	Fixing screws (rail adapter)
18	Clamping jaw (fast clamping system)
19	Accelerator
20	Ignition switch
21	Fuel tap

Delivery contents

	Rail core driller with petrol engine
A	Rail adapter of your choice (no special designs)
	Offset screwdriver (SW 4 + 5); (not illustrated)
	High-pressure container 5l for cutting/ drilling emulsion (not illustrated)
	Operating instructions

Before using for the first time

Transport inspection

As standard, the machine is supplied with the components indicated in the **Delivery contents** section.

NOTE

- ▶ Inspect the delivery for completeness and obvious signs of damage. Report an incomplete or damaged delivery to your supplier/retailer immediately.

Preparation

This section contains important instructions on required preparation before starting work.

The machine is intended to be used in a horizontally-aligned work position at close proximity to the ground.

Additional safety measures when not in a horizontal work position at close proximity to the ground

WARNING

Risk of injury from a falling machine.

When not working in a horizontal work position at close proximity to the ground, the machine must be secured against falling down.

- ▶ Use suitable slinging or hoisting equipment to secure the machine.
- ▶ Before beginning any work, check secure positioning of the safety measures.
- ▶ Use the protective equipment stipulated in the section **Personal protective equipment**.

Checking the rail type

The holding force of the fast clamping system (5) depends on the fitting accuracy of the rail adapter (6) to the rail.

The following requirements must be fulfilled in order to establish sufficient holding force:

- Only the rail adapters (6) associated with the rail type may be used.

NOTE

- ▶ In addition to the rail adapters (A) listed in the range of accessories, BDS offers special adapters for special rails on request.

Mounting the rail adapter

The machine is equipped with a socket for various rail adapters (A).

The corresponding adapter set must be used according to the type of rail.

Rail type	Order number rail adapter
UIC 50	ZAS 250U
UIC 54	ZAS 254U
UIC 60	ZAS 260U
S 49	ZAS 249S
S 54	ZAS 254S
Other	On request

WARNING

Risk of injury!

Incorrectly, damages or improperly mounted rail adapters (6) decrease the holding force of the fast clamping system (5), this can lead to injuries

- ▶ Only use the matching rail adapter (6) for the respective rail type.
- ▶ Do not use damaged, contaminated or worn tools rail adapters (6).
- ▶ Change the rail adapter only when the machine is switched off and at a standstill. Put the machine into a safe condition.
- ▶ Change the rail adapter only when the fast clamping system (5) is not tensioned.

WARNING

- ▶ After mounting, check for secure, firm seating of the rail adapter (6).
- ▶ Only use tools, adapter and accessories that match the machine.

Mounting the rail adapter (6)

- ◆ Loosen both fixing screws (17) of the rail adapter set on each respective side.
- ◆ Insert both rail adapters (6) and tighten the fixing screws (17).

Dismantling the rail adapter

- ◆ Loosen both fixing screws (17) of the rail adapter set on each respective side.
- ◆ Remove both rail adapters (6).

Inserting the tool

The machine is equipped with a 19 mm Weldon (3/4") direct mounting.

Tools:

Only core drills with a 19 mm Weldon shaft (3/4") can be used (HKK-R). The cutting depth is limited by the maximum stroke of 40 mm.

WARNING

Risk of injury!

- ▶ Do not use damaged, contaminated or worn tools.
- ▶ Only perform tool changing when the machine is switched off and not moving.
- ▶ Ensure that the machine is in a safe condition.
 - Move the accelerator (19) to the MIN position.
 - Move the ignition switch (20) of the engine (12) to the OFF/AUS position.
 - Close the fuel tap (21).
 - Pay attention to the engine specifications of the manufacturer (12).
- ▶ After inserting, check that the tool is engaged securely.
- ▶ Only use tools, adapter and accessories that match the machine.

Inserting the tool

- ◆ Before mounting, clean the shank of the tool and the direct mounting of the machine.
- ◆ Insert the corresponding ejector pin into the core drill.
- ◆ Insert the tool into the direct mounting of the machine from the front.
- ◆ Secure the tool by tightening the safety screws (Allen head screws) in the direct mounting.

WARNING

Risk of injury!

Risk of injury from incorrectly inserted, not secured or improperly secured tool.

- ▶ Check the proper seating of the tool in the tool mounting.
- ▶ Only tighten the Allen head screws of the direct mounting with a suitable tool (offset screwdriver supplied).
- ▶ After tightening/untightening the Allen head screws, pull the offset screwdriver out of the screw.

Removing the tool

- ◆ Loosen the safety screws (Allen head screws) on the direct mounting.
- ◆ Remove the tool from the direct mounting from the front.

Coolant/lubrication

The back of the machine is equipped with a coolant/lubrication connector (10) in order to connect the high-pressure container supplied. This allows the core drill and the cutting surface to be supplied with coolant/lubrication.

Connect the high-pressure container:

- ◆ Push the hose of the high-pressure container into the coolant/lubrication connector (10) until it audibly snaps in.

Release the high-pressure container:

- ◆ Depressurise the high-pressure container.
- ◆ Remove the hose by pulling back the safeguard on the connection coupling.

NOTE

- ▶ Remove excess coolant/lubrication with appropriate means (e.g.: cloth,...).

Preparing the engine

⚠ WARNING

Risk of injury!

- ▶ Carry out all work on the engine (12) only when the machine is switched off and at a complete stop.
- ▶ Ensure that the machine is in a safe condition.
 - Move the accelerator (19) to the MIN position.
 - Move the ignition switch (20) of the engine (12) to the OFF/AUS position.
 - Close the fuel tap (21).
 - Pay attention to the engine specifications of the manufacturer (12).
- ▶ Allow the machine to cool down before starting any work on the engine (12).

CAUTION

Potential damage to property if the machine is improperly refuelled!

Observe the following instructions to avoid damage:

- ▶ Only use the prescribed fuels and lubrication as well as specified amounts.

Recommended fuel:

Lead-free petrol, 95 octane

Recommended engine oil:

SEA 10W-30

(Pay attention to the manufacturer documentation on the engine (12).)

- ▶ Absorb excess fuels and lubricants immediately with suitable means.
- ▶ Carry out all work on the engine (12) on a firm, flat and level surface.

Refuelling the machine

- ◆ Screw off the tank lid (1).
- ◆ Fill with fuel
- ◆ Screw in the tank lid (1).

Checking/filling oil

- ◆ Open the oil filler neck (9).
- ◆ Check the oil level with the help of the dipstick on the cap of the oil filler neck (9) (pay attention to the manufacturer documentation).
- ◆ Refill with oil if necessary.
- ◆ Close the oil filler neck (9) with the cap.

Use**Fixing the machine****Tensioning the fast clamping system**

- ◆ Insert the machine with the rail adapter (6) into the rail profile at right angles to the rail.
- ◆ Press the clamping jaw (18) onto the rail by turning the spindle key (3).

Slackening the fast clamping system

- ◆ Secure the machine at the handle (2) to stop it from slipping.
- ◆ Release the clamping jaw (18) from the rail by turning the spindle key (3)
- ◆ Remove the machine from the rail.

Switching the machine ON/OFF**Switching on the machine**

- ◆ Move the fuel tap (21) to the ON position.
- ◆ Move the choke (15) to the CLOSED position.
(to restart a warm engine (12), leave the choke (15) in the opened position.)
- ◆ Move the accelerator (19) to the MAX position.
- ◆ Switch on the ignition (20) (ON position).
- ◆ Start the engine (12) with the help of the starter handle (4). For this purpose, pull the starter handle (4) lightly until resistance is felt, then start the engine (12) by pulling rapidly.
- ◆ Allow the engine (12) to warm up and move the choke (15) back to the OPEN position.

Switching off the machine

- ◆ Move the accelerator (19) to the MIN position.
- ◆ Switch off the ignition (20) (OFF position).
- ◆ Move the fuel tap (21) to the OFF position.

NOTE

- ▶ Pay attention to the manufacturer documentation when starting and switching off the engine (12).

⚠ WARNING**Risk of injury from engine starting unintentionally!**

Pay attention to the following safety notes to avoid danger from the engine (12) starting unintentionally.

For safe stopping of the engine (12):

- ▶ Move the accelerator (19) to the MIN position.
- ▶ Move the ignition switch (20) of the engine (12) to the OFF/AUS position.
- ▶ Close the fuel tap (21).
- ▶ Pay attention to the engine specifications of the manufacturer (12).

Setting the speed

The rotation speed is determined by the engine speed.

The position of the accelerator (19) determines the speed of the drill.

- MAX position
= max. speed (225 rpm)
- MIN position
= min. speed (150 rpm)

Drilling with the machine**Drilling with core drills**

When drilling with core drills, proceed as follows:

- ◆ Insert the core drill into the 19 mm Weldon (3/4") direct mounting of the machine as described in the section ***Inserting the tool.***
- ◆ Position the machine at the location of use, align it and fix the machine with the fast clamping system (5).
- ◆ Connect the high-pressure container as described in the section ***Coolant/lubrication.***
- ◆ Pressurise the cooling/lubrication system (approx. 2-3 strokes with the hand pumping device of the high-pressure container).
- ◆ Switch the machine on.
- ◆ Guide the machine carriage with the help of the feed lever (8) and without exerting too much pressure until the desired core drill is established.

NOTE

Observe the following instructions when drilling with core drills:

- ▶ Drilling with core drills does not require great effort. The drilling process is not accelerated by higher pressure. The drill wears faster and the machine can be overloaded.
- ▶ Use the high-pressure container supplied for cutting oil/drilling emulsion with BDS 6000 cooling lubricant at the machine.
- ▶ Pay attention to the production of swarf. With larger drilling depths, break the chip.

Eliminating blockages

WARNING

Danger of cutting by broken tool parts or shavings.

- ▶ Put protective gloves on before starting work.

Before eliminating a blockage, stop the machine completely.

For safe stopping of the engine (12):

- ▶ Move the accelerator (19) to the MIN position.
- ▶ Move the ignition switch (20) of the engine (12) to the OFF/AUS position.
- ▶ Close the fuel tap (21).
- ▶ Pay attention to the engine specifications of the manufacturer (12).

Blockages caused by a broken tool:

- ◆ Move the machine carriage to the base position with the help of the feed lever (8).
- ◆ Replace defective tool. Remove shavings.

Other blockages:

- ◆ Move the machine carriage to the base position with the help of the feed lever (8).
- ◆ Remove shavings and check tool.

Cleaning**⚠ WARNING****Risk of injury!**

Risk of injury in the case of improper cleaning work. To avoid injury, pay attention to the following instructions:

- ▶ Before any maintenance and cleaning, switch off the machine and stop the engine (12) completely
 - Move the accelerator (19) to the MIN position.
 - Move the ignition switch (20) of the engine (12) to the OFF/AUS position.
 - Close the fuel tap (21).
 - Pay attention the engine specifications of the manufacturer (12).
- ▶ When using compressed air, wear protective goggles and gloves.
- ▶ Protect other persons in the work area.

CAUTION

- ▶ Never immerse the machine in water or other liquids.

After every use

- ◆ Remove the inserted tool.
- ◆ Remove shavings and coolant residues.
- ◆ Clean the tool and the tool holder on the machine.
- ◆ Clean the guide of the machine slide (13).
- ◆ Store the machine and accessories at a suitable location (see section **Storage**).

NOTE

- ▶ Pay attention to the manufacturer documentation when cleaning the engine and gear unit.

Maintenance

WARNING

Danger caused by unqualified repairs!

Unqualified repairs can lead to considerable danger for the user and cause damage to the machine.

- ▶ Maintenance work may only be carried out by authorised qualified staff.
- ▶ Only original spare parts may be used.

Adjusting the guide of the machine slide

If the machine slide guide (13) exhibits too much clearance, it must be adjusted. To do this, proceed as follows:

- ◆ Loosen the clamping bolts.
- ◆ Tighten the adjusting screws uniformly.
- ◆ Tighten the clamping bolts again.

NOTE

- ▶ Pay attention to the manufacturer documentation when carrying out maintenance on the engine and gear unit.

Customer service/service

Should you have any questions about after-sales service or service, please contact BDS. We will be happy to give you the address of your nearest service partner.

Storage

If you do not intend to use the machine for a longer period of time, clean it as described in the section **Cleaning**. Store the machine and all accessories at a dry, clean and frost-free location.

Troubleshooting

Fault	Possible cause	
The engine (12) does not start.	Fuel supply faulty.	Check the fuel level and refuel if necessary. Open the fuel tap.
	Motor oil level too low.	Check the oil level and refill if necessary.
	Ignition (20) not switched on.	Switch on the ignition.
	Choke (15) not at a suitable start position.	Check the position of the choke. (CLOSED position for cold starting)
	Pay attention to the manufacturer documentation for further troubleshooting.	
Tools wear excessively/ are damaged.	No lubrication or not sufficiently greased.	Supply lubrication (e.g.:use high-pressure container for cutting oil/drilling emulsion).
The fast clamping system (5) does not fix the machine to the rail properly.	Wrong rail adapter (A) selected.	Select and mount a suitable rail adapter (A).

NOTE

- If you cannot resolve the problem with the steps described above, please contact the After-Sales Service.

Technical Specifications

Model	RailMAB 960	Unit
Dimensions (L x W x H)	535 x 345 x 470	mm
Net weight approx.	21.5	kg
Cylinder capacity	49.4	cm ³
Tank capacity	0.5	l
Motor power	1.5	kW
Max. torque	3.04 Nm at 4500 rpm	W
Stroke	40	mm
Core drill (HKK-R) max. Ø	17 - 36	mm
Cutting depth max.	30	mm
Speed (adjustable)	150 - 225	rpm
Core drill assembly	Weldon 19 mm (3/4")	

EC Declaration of Conformity

Name/address of manufacturer:	BDS Maschinen GmbH Martinstraße 108 D-41063 Mönchengladbach
We hereby declare that the product	
Model:	Rail core drill with petrol engine
Type:	RailMAB 960
conforms to the following relevant regulations: ■ EC Directive 2006/42/EC	
The following harmonised standards were applied in whole or in part: ● DIN EN ISO 12100-2010 ● DIN EN 61000-6-4:2007 +A1:2011	
Responsible person for documentation according to EC Directive 2006/42/EC - Annex II Pt.A.2. was: _____ (Surname, forename, position in company of the manufacturer)	
Mönchengladbach, 1st February, 2014	 Wolfgang Schröder, Technical Director _____ (Legally binding signature of the issuer)

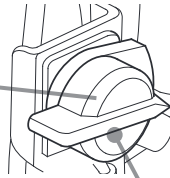
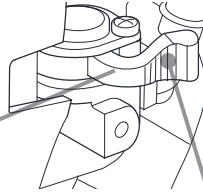

19

20

21



A

BDS Maschinen GmbH

Martinstraße 108
D-41063 Mönchengladbach

Fon: +49 (0) 2161 / 3546-0

Fax: +49 (0) 2161 / 3546-90

Internet: www.bds-maschinen.de

E-mail: info@bds-maschinen.de
