

# EKF 300.3 – EKF 450.3 – EKF 452.3

Deburring and chamfering machines for quick and precise edge processing 20°, 45° or R 2.5 mm.

**Deburring and chamfering with machines from the EKF series.** The BDS deburring and chamfering machine can be universally used for industry and craft: In mould making, boiler construction, plant construction, mechanical engineering and for sheet metal working.

The EKF machine is ideally suited for deburring and chamfering of parts made of steel, stainless steel, non-ferrous metals, brass and plastic. Due to its handy, compact design, the machine can be used on straight edges, internal and external radii and for drill holes from  $\varnothing$  22 mm. The fine adjustment allows slight chamfers for deburring up to the preparation of welding seams.



Three milling cutters with a chamfering angle of 45°, optionally 30° or a radius of 2.5 mm are available.

The reversible disks can be used in 3 ways. Due to the small guiding roller, insertion into drill holes from  $\varnothing$  22 mm is possible without any problems.



Edge processing with the EKF - the workpiece is securely fixed with the MagnetCLAMP magnetic clamping device. See page 79.

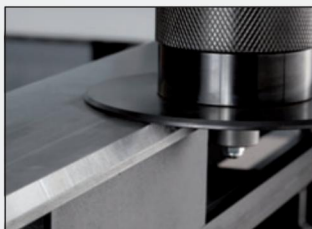
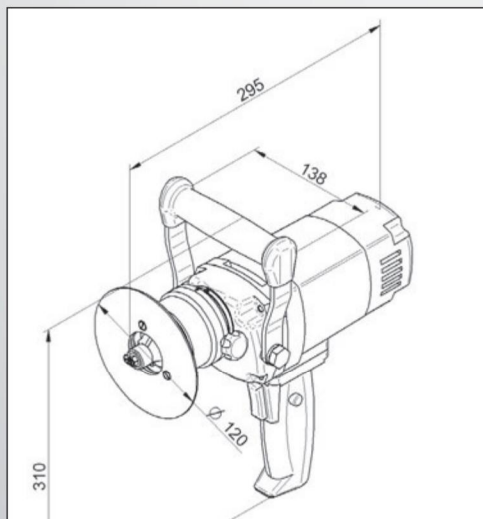

Cutting angle  
30°



EKF 300.3 with milling cutter ZFR

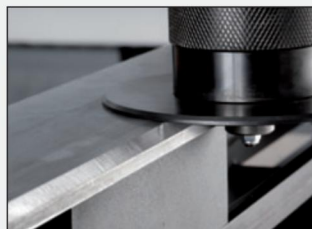

Cutting angle  
45°



EKF 450.3 with milling cutter ZFR 450.3

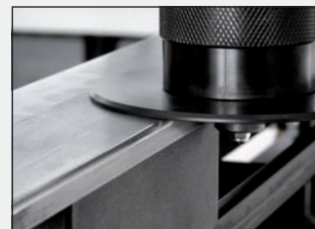

Radius  
R 2.5 mm



EKF 452.3 with milling cutter ZFR 452.3









Visit our homepage to experience live the EKF demo video.  
[http://www.kernbohrer.de/downloads/downloads.html#tab\\_4](http://www.kernbohrer.de/downloads/downloads.html#tab_4)



## The advantages of the EKF

- > Straightforward – easy handling, low weight
- > Variable – 3 milling cutters optionally 45°, 30°, or R 2.5 mm
- > Powerful – 1.5 kW motor

### SPECIFICATION

	Motor output:	1500 Watt
	Voltage:	220 - 240 V AC, 50-60 Hz
	Speed range 1:	6000 min <sup>-1</sup>
	Feed:	manual
	Milling cutter optional:	Fase 45° – width continuously 0 - 6 mm Fase 30° – width continuously 0 - 5 mm Radius R 2.5 mm
	Carbide reversible disks:	3 per milling cutter
	Weight:	4.6 kg

### ACCESSORIES

#### ORDER NO.

#### Milling cutter

ZFR 300.3 – 30°
ZFR 450.3 – 45°
ZFR 452.3 – R 2.5

Carbide reversible disks are not included in delivery. Please clearly order them as an extra.

#### Carbide reversible disks

SHM 200	1 pc.
SHM 200-E	1 pc.
SHM 202	1 pc.

1 set = 3 carbide reversible disks SHM



Changeable carbide reversible

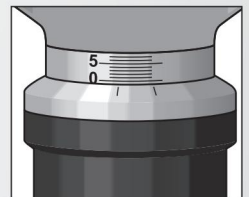

Fine adjustment

### ORDER NO.

EKF 300.3 / 230 Volt
EKF 300.3 / 110 Volt
EKF 450.3 / 230 Volt
EKF 450.3 / 110 Volt
EKF 452.3 / 230 Volt
EKF 452.3 / 110 Volt

### SCOPE OF DELIVERY

1 Deburring and chamfering machine	1 Sickle spanner
1 Milling cutter	1 Torx screwdriver T9
3 Carbide reversible disks	1 Operating manual
1 Jaw spanner SW 22	
1 Carry case	